

English edition

PROTOCOLS, DECISIONS, RESOLUTIONS

CONTENTS: PAGES

1. PROTOCOL AND SUPPLEMENTARY PROTOCOLS

- (i) Convention on the Temporary Importation of Passenger Vehicles in Member States. 1
- (ii) Supplementary Protocol on the Code of Conduct for the Implementation of the Protocol on the Free Movement of Persons, the Right of Residence and Establishment. 1

2. DECISIONS

(a) OF THE AUTHORITY OF HEADS OF STATE AND GOVERNMENT

- (i) Decision of the Authority of Heads of States and Government of the Economic Community of West African States relating to the Confirmation of the Appointment of Mr. Momodu Munu as Executive Secretary of the Economic Community of West African States. 16
- (ii) Decision of the Authority of Heads of State and Government of the Economic Community of West African States relating to the establishment of the ECOWAS Travel Certificate for Member States. 16

(b) OF THE COUNCIL OF MINISTERS

- (i) Decision of the Council of Ministers relating to the confirmation of the appointment of the Managing Director of the ECOWAS Fund. 19
- (ii) Decision of the Council of Ministers relating to the Financing of the Construction of the Headquarters of the ECOWAS Fund in Lome (Republic of Togo). 19
- (iii) Decision of the Council of Ministers relating to the Choice of a Model for the construction of the Headquarters of the Executive Secretariat in Abuja (Federal Republic of Nigeria.) 20
- (iv) Decision of the Council of Ministers relating to the Financing of the Headquarters of the Executive Secretariat. 20
- (v) Decision of the Council of Ministers relating to the choice of project Management Consultant for Construction of the Headquarters of the Fund in Lome, Republic of Togo. 21
- (vi) Decision of the Council of Ministers relating to the choice of Control Bureau for the Construction of the Headquarters of the ECOWAS Fund in Lome, Republic of Togo. 22

- (vii) Decision of the Council of Ministers establishing a consultation and co-ordination Committee between ECOWAS Member States for the programming of trade fairs and similar commercial events. 22
- (viii) Decision of the Council of Ministers on the creation of an Ad Hoc Ministerial Committee to examine problems related to the economic crisis in Members States of the Community. 23

3. RESOLUTIONS

OF THE COUNCIL OF MINISTERS

- (i) Resolution of the Council of Ministers relating to the Confirmation of the appointment of Mr. Momodu Munu as Executive Secretary of the Economic Community of West African States. 25
- (ii) Resolution of the Council of Ministers relating to the adoption of a supplementary protocol on the code of conduct for the implementation of the protocol on the free movement of persons, right of residence and establishment.
- (iii) Resolution of the Council of Ministers on the establishment of a travel certificate for ECOWAS Member States. 25
- (iv) Resolution of the Council of Ministers relating to the adoption of a convention on the temporary importation of passenger vehicles into Member States.

A/P 1/7/85 CONVENTION ON THE TEMPORARY IMPORTATION OF PASSENGER VEHICLES INTO MEMBER STATES

THE HIGH CONTRACTING PARTIES

CONSIDERING Article 23 of the ECOWAS Treaty,

CONSIDERING Article 5 of the Protocol on the Free Movement of Persons, the right of residence and establishment.

DESIROUS of promoting an effective implementation of the Protocol on the Free Movement of Persons, Right of Residence and Establishment signed on 29 May, 1979 in Dakar, particularly in respect of the movement of passenger vehicles.

CONSCIOUS of the need to regulate the temporary importation of passenger vehicles into a Member State whereas they are registered in another Member State.

CONVINCED that the adoption of common procedures in respect of temporary importation of passenger vehicles will ensure the customs systems of Member States of a greater degree of harmonisation and uniformity.

DECIDE TO CONCLUDE a Convention between themselves on the temporary importation of private passenger vehicles registered in Member States of the Community, and agree on the following provisions :

CHAPTER 1: DEFINITIONS

Article 1

For the purpose of this Convention :

"Community" means the Economic Community of West African States ;

"Member State" or "Member States" means the Member State or the Member States of the Economic Community of West African States ;

"Authority" means the Authority of Heads of State and Government established by Article 5 of the Treaty ;

"Executive Secretary and Executive Secretariat" means the Executive Secretary and the Executive Secretariat of the Community as defined in Article 8 of the Treaty ;

"Import duties and taxes" mean customs duties and all duties and taxes chargeable by reason of importation ;

"Vehicles" mean passenger vehicles (road motor vehicles, including motorcycles) and trailers (imported with the vehicles, or separately) registered in any one of the Member States (and including the accessories and normal component parts imported with the vehicles) ;

"Accessories and normal component parts" mean those elements delivered with the vehicle from the factory ;

"Private use" means use of the vehicle for purposes other than the conveyance of fare-paying passengers, for gain or any other material consideration, and other than the conveyance of industrial or commercial goods, with or without remuneration ;

"Commercial use" means use of the vehicle for the conveyance of fare-paying passengers, for gain or any other material consideration within its country of registration ;

"Temporary importation permit" means the customs document on which the guarantee or consignment of import taxes and duties is entered ;

"Persons" means individual or legal entities ;

"Resident" means any person whose permanent residence is in a Member State, and who resides there more than six months in a year, or who owns a permanent commercial or industrial enterprise or carries on any other remunerative activity in the said State ;

"Temporary admission" means importation, free of all import duties and taxes, subject to the conditions laid down by this convention or by the laws and regulations of the country of importation ;

"Issuing Association or Body" means an association or body approved by the competent authorities of a Member State, and authorised to issue customs clearance papers ;

"Guaranteeing Association or Body" means an association or body approved by the customs authorities of a Member State and authorities to guarantee the duties, taxes and other sums chargeable for non-compliance with the conditions governing temporary admission of vehicles into the territory of that Member State.

CHAPTER II: SCOPE OF IMPLEMENTATION

Article 2

1. : Each Member State of the Community shall grant temporary admission free of import duties and taxes, without import prohibitions or restrictions subject to re-exportation under the conditions laid down by this Convention, to passenger vehicles owned by persons normally resident outside its territory, and which are being imported for private or commercial use during a visit either by owners of these vehicles or by other persons normally resident outside its territory.

2. At the time of importation, these vehicles shall be covered by a temporary import permit guaranteeing payment of import duties and taxes waived and any customs penalties incurred.

3. Vehicles belonging to Diplomatic Missions and International Organisations, and all other official vehicles covered by a travel authorisation, are excluded from the provisions of paragraphs 1 and 2 above.

Article 3

The following are admitted without payment of import duties and taxes and free of import prohibitions and restrictions :

Fuel and petrol contained in the normal fuel tanks of vehicles temporarily imported, it being understood that the normal fuel tank is that designed by the maker for the type of vehicle concerned.

CHAPTER III : ISSUE OF TEMPORARY IMPORT PERMITS**Article 4**

1. In conformity with the guarantees, and under such conditions as it may lay down, each Member State may authorise Associations and Bodies, especially those affiliated to an International Organisation to issue and deliver the temporary import permits provided for by this Convention.

2. Temporary import permits are valid in all customs territories of Member States.

3. Each Member State shall accept in place of its national customs papers, the import permit indicated in Article 5.1 hereafter which guarantee the payment of import duties and taxes and any customs penalties incurred.

4. (a) The period of validity shall not exceed one year from the date of issue.
- (b) The maximum duration of temporary importation shall not exceed ninety (90) days for private vehicles and fifteen (15) days for commercial vehicles. Any day begun is considered a full day.

Article 5

1. Temporary importation papers valid for the customs territories of all Member States shall be known and entitled "Customs Clearance Booklet" and must conform to the sample attached to this Convention.

2. Any issuing association or body from a given Member State must indicate on the cover leaf of the "Customs Clearance Booklet" the names of the other fifteen (15) Member States for which the Booklet is valid, as well as the corresponding guaranteeing associations or bodies in the Member State into which the vehicle is being imported.

3. Each Member State shall transmit to the other Member States, and to the Executive Secretariat, its own sample of the "Customs Clearance Booklet".

CHAPTER IV: PARTICULARS TO BE DECLARED IN THE CUSTOMS CLEARANCE BOOKLET**Article 6**

1. "Customs Clearance Booklets" issued by

authorised Associations and Bodies shall be made out in the name of the persons who own the vehicles temporarily imported.

2. The holder shall sign the Customs Clearance Booklet at the bottom of page two (2) of the cover and undertake to respect the regulations applicable to vehicles in the importing Member State, and re-export the vehicle within the prescribed period of validity, failing which the penalties stipulated by the customs laws of the host Member State shall be imposed without prejudice to the payment of duties and taxes due.

Article 7

1. Page two (2) of the cover and each leaf of the Booklet shall carry all the information necessary for the identification of the vehicle and the payment of any duties and taxes.

- registration number and country of registration
- make and type of vehicle, type of body, serial number, engine number, number of cylinders and horse power
- vehicle colour, upholstery, number of seats or load capacity
- radio and other gadgets
- net weight of vehicle in kilogrammes, date of purchase, date of insurance, value of vehicle
- name of owner.

2. In addition to this information the residence leaflets shall bear the name and address of the issuing association or body; the name of the permit holder and their permanent or business address; the name of the driver and driving licence number; the type, number, date and place of issue of the drivers valid travel documents.

Article 8

1. Weight to be declared in the CUSTOMS CLEARANCE BOOKLET shall be the net weight of vehicle in kilogrammes.

2. Value to be declared in the CUSTOMS CLEARANCE BOOKLET shall be in the currency of the country in which the Booklet was issued.

3. Accessories and normal fittings imported with the vehicle shall be declared in the CUSTOMS CLEARANCE BOOKLET.

Article 9

Vehicles admitted under the cover of temporary importation CUSTOMS CLEARANCE PAPERS may be used, for private purposes, by third persons duly authorised by the holders of the clearance papers, normally residing outside the Member State of importation and fulfilling the other conditions laid down by this convention. The customs authorities of Member States have the right to demand evidence that such persons have been duly authorised by the holders of the papers and fulfil the afore-said conditions.

CHAPTER V. GUARANTEE

ARTICLE 10

1. Each guaranteeing Association or Body guarantees to the customs authorities of the country in which its headquarters is located, the payment of amounts accruing from import duties and taxes and other amounts chargeable as a result of non-compliance with the conditions governing temporary importation of vehicles into its territory under the cover of temporary importation of vehicle into its territory under the cover of temporary importation papers issued by a corresponding issuing Association or Body. They are held severally or jointly responsible with the persons so charged for the payment of the amounts mentioned above.

2. Customs Authorities may not in any circumstances demand from the guaranteeing Association or Body the payment of the import duties and taxes referred to in paragraph 1 of this Article if the claim has not been notified to the Association or Body concerned within 3 years of the date of expiry of the validity of the Booklet.

CHAPTER VI : CONDITIONS OF TEMPORARY IMPORTATION

ARTICLE 11

1. The vehicles mentioned in the "Customs Clearance Booklet" shall be re-exported in the same general state, except for wear and tear, within the authorised period of stay. In the case of vehicles which have been hired, customs authorities have the right to demand the re-exportation of the vehicles at the time the hirer leaves the Member State of temporary importation.

2. Evidence of re-exportation shall be provided by the exit visa properly appended to the Booklet by the Customs Authorities of the Member State into which the vehicle was temporarily imported.

ARTICLE 12

The re-exportation of badly damaged vehicles shall not be required provided that the vehicles' conditions are assessed by the Customs Authorities and such vehicles are :

- a. subjected to import duties and taxes to which they are liable ;
- b. abandoned free of all expense to the treasury of the Member State into which they are temporarily imported ;
- c. destroyed under official supervision at the expense of the parties concerned.

Article 13

Vehicles imported into the territory of one of the Member States under cover of the "Customs Clearance Booklet" may not be used even incidentally for transport against payments, reward or other consideration between points within the frontiers of that territory.

Article 14

A person entitled to temporary importation papers may during the period of validity of the "Customs Clearance Booklet" import the vehicle covered by the temporary importation papers as often as necessary on condition that they have each passage (entry and exit) established by a visa of the customs officers concerned and provided that the length of each stay does not exceed the period allowed.

CHAPTER VII: EXTENSION OF VALIDITY OF IMPORTATION PAPERS AND OF PERIOD OF STAY OF VEHICLE

Article 15

1. The provisions of Article 4 paragraph 4 above notwithstanding, the duration of the validity of "Customs Clearance Booklet" may be extended for a maximum period of one year.

2. Each Member State shall recognise as valid the extension of validity obtained in any other Member State.

Article 16

Extensions of stay for vehicles imported temporarily shall be granted when the persons concerned can establish to the satisfaction of the Customs Authorities that they are prevented by force majeure from re-exporting the said vehicles within the time allowed.

CHAPTER VII: REGULARISATION OF IMPORTATION PAPERS

Article 17

1. The re-exportation of vehicles temporarily imported into Member States under the cover of the temporary importation papers, shall be effected by returning the Exportation Voucher to the Customs entry-point of the Member State of importation.

2. In the event of destruction, loss or theft of a "Customs Clearance Booklet" while the vehicle is in the territory of one of the Member States, the Customs Authorities of State shall, at the request of the representative of the Association or Body concerned accept a replacement Booklet the validity of which shall coincide with the expiry date of the Booklet it replaces. This acceptance of the replacement document shall annul the previous acceptance of the paper destroyed, lost or stolen.

3. In case of destruction, loss or theft of a "Customs Clearance Booklet" which has not gone through re-exportation formalities the Customs Authorities may accept a certificate issued by the appropriate Authorities in place of the said Booklet

Article 18

1. In the case of non-re-exportation within the stipulated time of vehicles imported under cover of the "Customs Clearance Booklet" import duties and taxes due at the time of importation shall be paid compulsorily notwithstanding the penalties provided for under the legislation and regulations existing to that effect in the Member State concerned and imposed by the customs administration.

2. When proof of re-exportation of vehicles is not furnished by the guaranteeing association or its agent within the period of three years from the date of notification of the fact that the re-exportation counterfoil of the Customs Clearance Booklet has not been submitted import duties and taxes shall be charged.

Article 19

In the event of fraud, contravention or abuse, the Member States shall have the right to embark on legal proceedings against persons holding Customs Clearance Booklets or against their guaranteeing Associations for the recovery of the import duties and taxes and also for the imposition of any penalties to which such persons have rendered themselves liable

CHAPTER IX: MISCELLANEOUS PROVISIONS

Article 20

Neither the processing nor the stamping of the Customs Clearance Booklets under the provisions of this Convention shall give rise to any remuneration for such customs services rendered.

CHAPTER X: FINAL PROVISIONS

Article 21

Any dispute which may arise between Member States regarding the interpretation or application of this Convention shall be settled in conformity with

the procedure for the settlement of disputes stipulated in Article 56 of the Treaty.

Article 22

1. Any Member State may submit proposals for the amendment or revision of this Convention.

2. Any such proposals shall be submitted to the Executive Secretary who shall communicate them to other Member States within (30) thirty days of the receipt of such proposals. The amendments or revisions shall be examined by the Authority at the expiration of the thirty (30) days notice period given to Member States.

CHAPTER XI: DEPOSIT AND ENTRY INTO FORCE

Article 23

1. This Convention shall enter into force provisionally upon signature by the Heads of State and Government of Member States and definitively upon ratification by at least seven (7) signatory States in accordance with the constitutional procedures applicable for each signatory Member State.

2. This Convention and all the instruments of ratification shall be deposited with the Executive Secretariat which shall transmit certified true copies to all Member States and notify them of the dates of deposits of the instruments of ratification and shall register this Convention with the Organisation of African Unity, the United Nations Organisation and all other Organisations.

3. This Convention shall be annexed to and shall form an integral part of the Treaty.

In faith whereof, we the Heads of State and Government of the Economic Community of West African States have signed this Convention.

DONE IN LOME THE 6TH OF JULY 1985 IN ONE SINGLE ORIGINAL IN THE ENGLISH AND FRENCH LANGUAGES. BOTH TEXTS BEING EQUALLY AUTHENTIC.

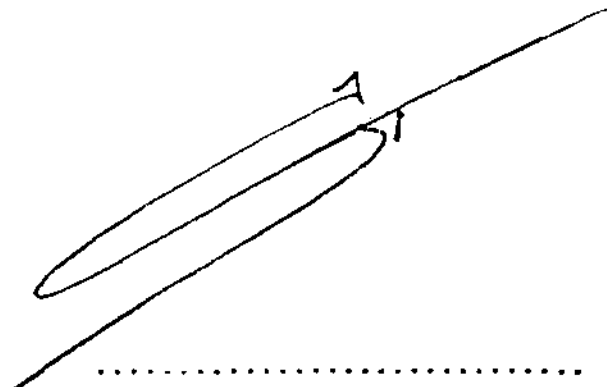

H.E. GENERAL MATHIEU KEREKOU
President of the Central Committee
of the People's Revolutionary Party
of Benin, President of the National
Executive Council, Head of State
President of Benin Republic

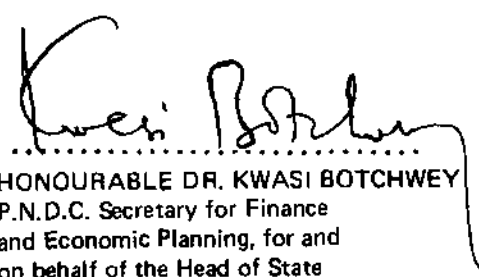

HONOURABLE DR. KWASI BOTCHWEY
P.N.D.C. Secretary for Finance
and Economic Planning, for and
on behalf of the Head of State
of the Republic of GHANA

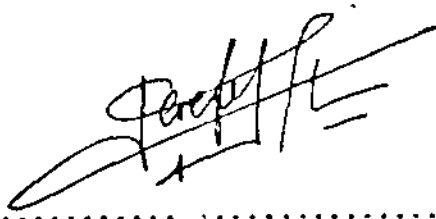

H.E. CAPTAIN THOMAS SANKARA
President of FASO

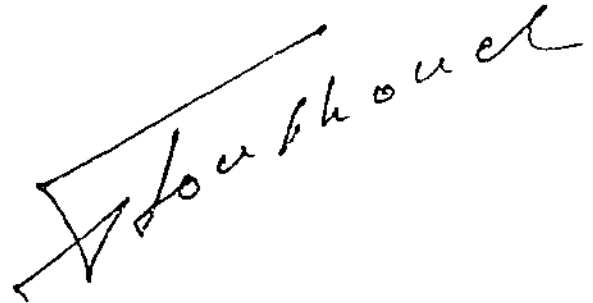

H.E.MR. FELIX HOUPHOUËT- BOIGNY
President of the Republic of
IVORY COAST

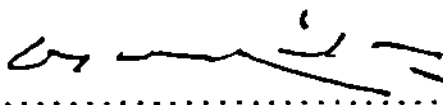

HONOURABLE OSWALDO LOPEZ DA SILVA
Minister of Economic Affairs and
Finance, for and on behalf of
the President of the Republic of
CAPE VERDE



H.E. SIR DAUDA JAWARA
President of
THE GAMBIA

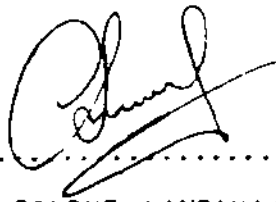

H.E. COLONEL LANSANA CONTE
President of the Republic of
GUINEA

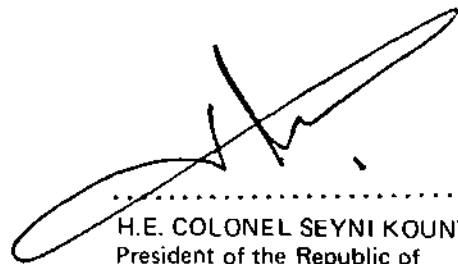

H.E. COLONEL SEYNI KOUNTCHE
President of the Republic of
NIGER



HONOURABLE MR. MARIO CABRAL
Minister of Commerce and
Tourism, for and on behalf
of the President of
GUINEA BISSAU

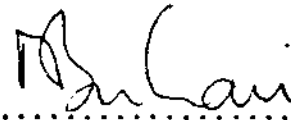

H.E. GENERAL MUHAMMADU BUHARI
Head of State of the Federal
Republic of NIGERIA

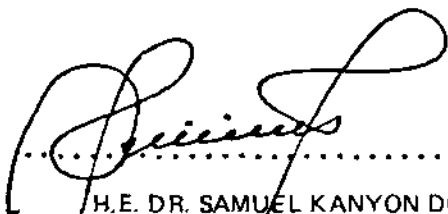

H.E. DR. SAMUEL KANYON DOE
Commander-in-Chief, Chairman
of the People's Redemption
Council and Head of State
of LIBERIA

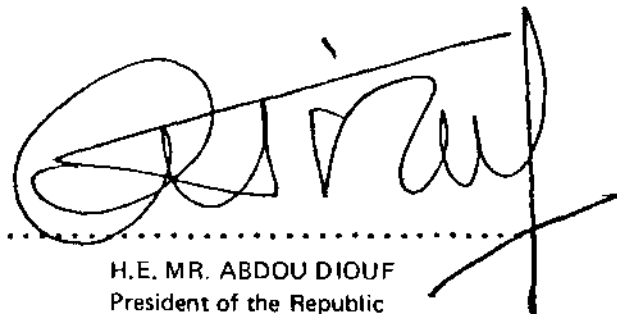

H.E. MR. ABDOU DIOUF
President of the Republic
of SENEGAL

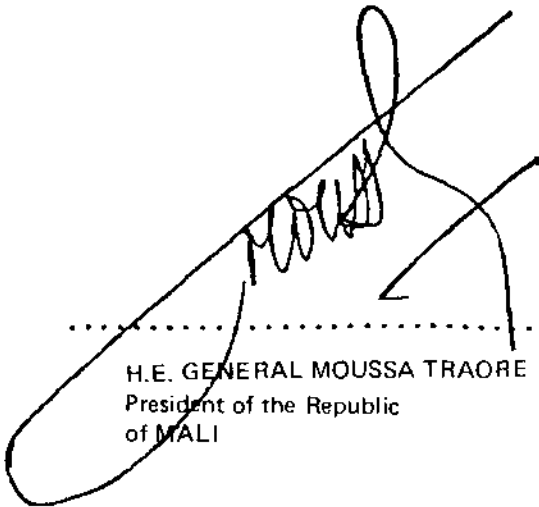

H.E. GENERAL MOUSSA TRAORE
President of the Republic
of MALI



H.E. DR. SIAKA STEVENS
President of the Republic
of SIERRA LEONE



HONOURABLE LT. COL. ANNE MAMADOU BABALY
Minister of Finance and Commerce,
for and on behalf of the President
of the Islamic Republic of
MAURITANIA

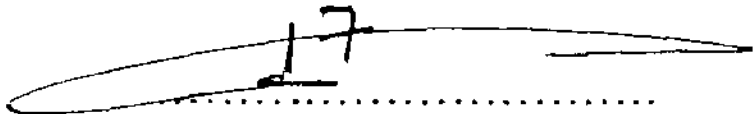

H.E. GENERAL GNASSINGBE EYADEMA
President of the Republic of
TOGO

ECONOMIC COMMUNITY OF WEST AFRICAN STATES
CUSTOMS CLEARANCE BOOKLET FOR
PASSENGER VEHICLES

- All particulars of the Customs Clearance Booklet shall be printed in English and French
- The dimensions shall be 22 x 27 cm
- The Issuing Association shall insert its name on each voucher and also include where applicable, the abbreviation of the International Organisation to which it is affiliated.

ECONOMIC COMMUNITY OF WEST AFRICAN STATES
CUSTOMS CLEARANCE BOOKLET FOR PASSENGER VEHICLES

MEMBER STATE

ASSOCIATION

INTERNATIONAL ORGANISATION:

No _____

Valid for one year that is, until _____ (insert date in red ink) inclusive

Subject to compliance by the holder during this period with the Customs laws and regulations of the country visited.

ISSUED BY _____

HOLDER _____
(Block Letters)

PERMANENT OR BUSINESS ADDRESS _____
(Block Letters)

This document is only valid in the following countries:

- | | | |
|-------------------------------|------------------------------------|---------------------------------|
| 1. People's Republic of BENIN | 7. Republic of GUINEA | 12. Republic of NIGER |
| 2. BURKINA FASO | 8. Republic of GUINEA BISSAU | 13. Federal Republic of NIGERIA |
| 3. Republic of CAPE VERDE | 9. Republic of LIBERIA | 14. Republic of SENEGAL |
| 4. Republic of IVORY COAST | 10. Republic of MALI | 15. Republic of SIERRA LEONE |
| 5. Republic of the GAMBIA | 11. Islamic Republic of MAURITANIA | 16. Republic of TOGO |
| 6. Republic of GHANA | | |

1

DESCRIPTION OF VEHICLE

1. Motor vehicle driven by internal combustion, electricity, steam; trailer.
2. Type (car, bus, lorry, van, tractor, motorcycle with or without side-car cycle with auxiliary engine) *
3. Registered in
4. Registration No.
(Make
5.
(No.
6. Chassis (Type of Shape
7. Body (Colour
8.
(Upholstery
9.
(Number of Seats
10.
(or Carrying capacity
11.
12. Engine (Make
13. (No.
14.
(Number of Cylinders
15.
(Horse Power
16. Spare Tyres
17. Radio
18. Other Particulars
19. Net weight of vehicles (kg)
20. Date first put on the road
21. Value of Vehicle

EXTENSION OF VALIDITY OF THE BOOKLET

1. The Holder of this Booklet is bound to re-export the vehicle within the period specified and to comply with the laws and customs regulations on temporary importation of motor vehicles in the Member States visited, under the guarantee of the Guaranteeing Association of each Member State.
2. Upon expiry this Booklet should be returned to the Association which issued it.

OBLIGATION OF HOLDER

Signature of Holder	Signature of the representative of the International Organisation if the issuing Association is affiliated to an International Organisation	Signature of the Authority representing the Association issuing the Booklet
---------------------	---	---

COUNTERFOIL

1. Importation into
2. Of Vehicle described in Booklet
3. No.
4. Took place on.
5. At the Customs Office of
6. Voucher Registration No.
8. Driving Licence No.
9. Identification
- Type
- No.
10. Address in the country visited
11. Customs Stamp :
Customs Officer's Signature
AND Visa
12. Exported from
13. Took place on.
14. At the Customs Office of
15. Duration of Stay
16. Customs Stamp

EXPORTATION VOUCHER

2. Of Customs Clearance Card No.
3. Valid until
4. Issued by
5. Holder
6. Permanent or Business Address
7. Address in country visited.
8. For a motor vehicle driven by internal combustion, electricity, steam, trailer Type (car, bus, van, tractor, motor-cycle with or without side-car, cycle with auxiliary engine)
9. Registered in
10. Registration No.
11. Chassis
12. Make.
13. No.
- Body.
14. Type or Shape
15. Colour
16. Upholstery.
17. Number of seats or carrying capacity
18. Make.
19. No.
20. Number of cylinders
21. Horse power
22. Spare Tyres
23. Radio (indicate make)
24. Other particulars.
25. Net weight of vehicle in kg
26. Date first put on the road
27. Value of vehicle
28. Date of re-exportation
29. At the Customs Office of
30. Booklet registered under No.
31. Customs Stamp/Customs Officer's Signature
32. To be returned to the Customs Office of importation at
33. Where the Customs Clearance Booklet has been registered under No.

IMPORTATION VOUCHER

2. Of Customs Clearance Card No.
3. Valid until
4. Issued by
5. Holder
6. Permanent or Business Address
7. Address in country visited.
8. For a motor vehicle driven by internal combustion, electricity, steam, trailer Type (car, bus, van, tractor, motor-cycle with or without side-car, cycle with auxiliary engine)
9. Registered in
10. Under No.
11. Chassis
12. Make.
13. No.
- Body.
14. Type or Shape
15. Colour
16. Upholstery.
17. Number of seats or carrying capacity
18. Make.
19. No.
20. Number of cylinders
21. Horse power
22. Spare Tyres
23. Radio (indicate make)
24. Other particulars.
25. Net weight of vehicle in kg
26. Date first put on the road
27. Value of vehicle
28. Date of importation
29. At the Customs Office of
30. Booklet registered under No.
31. Customs Stamp/Customs Officer's Signature
32. Custom's Officer's Signature
33. N.B. The Customs Entry Post shall fill in lines 32 and 33 of the adjacent exportation voucher

INSTRUCTIONS

1. The Customs Clearance Booklet is issued to the Holder by an Association authorised by the Customs Administration of the State of his residence at a cost of.....*
2. The Holder must sign the Booklet at the bottom of the back outer cover.
3. Each Voucher covers a temporary stay within a Member State visited.
4. The total number of stays in a year shall not exceed 180 days.
5. Each day commenced is considered a full day.
6. On importation the Customs Entry Post shall detach and retain the Importation Voucher, append a visa on the Counterfoil and fill in lines 32 and 33 of the Exportation Voucher.
7. On re-exportation, the Customs Exit Post shall detach and retain the exportation voucher and append a visa on the Counterfoil.
8. The visa must include the customs stamp, date and signature of the Customs Officer. The Holder should verify on the spot that visas are authentic and complete in order to avoid any inconveniences later.
9. The Booklet must be filled in clearly and boldly, all alterations and additions are strictly forbidden. Any alteration must be approved and initialled by the competent Customs authority.
10. The Customs Clearance Booklet cannot be used either for final importation of a vehicle if the Holder has his principal residence in the Member State of importation or for lending the vehicle to a person who resides in the country of importation.
11. On expiry the Voucher must be returned to the authorized Issuing Association.
12. In the event of the Holder being in any difficulties in the Member State of temporary importation (as a result of loss of the Booklet for example), he should immediately notify the nearest Customs Office of that State and he should follow the instructions given to him.
13. The vehicle can neither be sold nor destroyed without permission and compliance with relevant Customs formalities and the Booklet should be returned thereafter to the authorized Association which issued it.
14. In the event of changes made to the vehicle (e.g.change of engine), the Holder must notify the Customs Administration of the Member State visited.

* Currency of State of residence

(BACK OUTER COVER OF CARD)

I declare that the particulars overleaf are true and correct, that I am normally resident outside the country of importation, that I am visiting that country for a temporary period, that I will comply with all customs conditions and requirements regarding the temporary importation of passenger vehicles and that I will re-export the vehicle referred to overleaf within the period of validity of this document.

...../Holder's Signature

At.....on..... 19.....

A/SP. 2/7/85 SUPPLEMENTARY PROTOCOL ON THE CODE OF CONDUCT FOR THE IMPLEMENTATION OF THE PROTOCOL ON FREE MOVEMENT OF PERSONS, THE RIGHT OF RESIDENCE AND ESTABLISHMENT.

THE HIGH CONTRACTING PARTIES,

- **MINDFUL** of the Treaty establishing ECOWAS, particularly its Article 2 paragraph (d) and Article 27, as amended by Decision A/DEC 8/5/82 of the Authority of Heads of State and Government dated 29 May, 1982;
- **CONSIDERING** the Protocol on Free Movement of Persons, the Right of Residence and Establishment;
- **CONVINCED** that the implementation by all Member States of the provisions of the texts on free movement of persons, goods, services and capital shall constitute the fundamental basis for building up ECOWAS and influencing the harmonious development of all economic, social and cultural activities within the sub-region, for the well-being of the peoples of Member States of the Community;
- **CONSCIOUS** of the urgent need to establish an effective and adequate cooperation between the administrations of Member States in view of the need for mutual administrative assistance between them on the free movement of persons, goods, services and capital;

HEREBY AGREE AS FOLLOWS :

**CHAPTER 1
DEFINITIONS**

Article 1

In this Protocol, and in the other Protocols relating to the implementation of the different phases of the Protocol on Free Movement of Persons, the Right of Residence and Establishment,

“Treaty” means the Treaty of the Economic Community of West African States ;

“Community” means the Economic Community of West African States ;

“Member State or Member States” means the Member State or Member States of the Community;

“Member State or Member States of origin” means the Member State or Member States of which the migrant is a national or an indigene;

“Host Member State or Member States” means the Member State or Member States in which the migrant is staying or residing;

“Authority” means the Authority of Heads of State and Government created by Article 5 of the Treaty;

“Executive Secretary and Executive Secretariat” means the Executive Secretary and the Executive Secretariat of the Community as defined in Article 8 of the Treaty;

“Community citizen or citizens” means any national or nationals of a Member State who fulfill the conditions stipulated in the Protocol A/P.3/5/82 establishing the Community Citizenship Code;

“Right of residence” means the right granted to a citizen who is a national of one Member State to reside in a Member State other than his State of origin which issues him with a Residence Card or Permit, enabling him to hold employment or otherwise;

“Resident” means any citizen who is a national of a Member State to whom the right of residence is granted ;

“Right of establishment” means the right granted to a citizen who is a national of one Member State to settle or establish in another Member State other than his State of origin, and to have access to economic activities, to carry out these activities as well as to set up and manage enterprises, and in particular companies, under conditions defined by the legislation of the host Member State for its own nationals ;

“Companies” means any company, including cooperative societies or any other legal entity governed by public or company law, with the exception of companies or societies which have no lucrative objective;

“Migrant” means a national of one Member State of the Community who has travelled from his country of origin to the territory of another Member State ;

“Illegal immigrant” means any immigrant citizen of the Community who does not fulfill the conditions stipulated in the different Protocols relating to the free movement of persons, the right of residence and establishment ;

“Competent Administrations” means the national administrations of Member States responsible for matters relating to the free movement of persons, services and capital ;

“Fundamental human rights” means the right of any individual recognised by the International Declaration of Human Rights adopted on 10 December, 1948 by the United Nations General Assembly.

CHAPTER II

ROLE AND OBLIGATIONS OF MEMBER STATES OF ORIGIN AND HOST MEMBER STATES OF IMMIGRANTS AND THE FORM OF CO-OPERATION REQUIRED BETWEEN COMPETENT ADMINISTRATIONS OF MEMBER STATES.

Article 2

1. Member States shall ensure that their nationals who travel to the territory of another Member State possess valid travel documents recognised within the Community.

2. Member States shall establish or strengthen appropriate administrative services in order to furnish migrants with all necessary information likely to permit legal entry into their territory.

3. In order to avoid illegal recruitment and its negative effects, Member States shall take all necessary measures to exercise stricter control on employers in their territories.

4. With a view to ensuring close cooperation between national administrations of Member States responsible for matters relating to the free movement of persons, goods, services and capital, and to ensure the harmonisation of techniques and methods of actions to be undertaken, Member States shall authorize the convening of regular meetings of the appropriate national officials for the exchange of all forms of information and experiences.

**CHAPTER III
RIGHTS AND OBLIGATIONS OF MIGRANTS IN
HOST MEMBER STATES AND CONDITIONS AND
PROCEDURES FOR EXPULSION.**

Article 3

1. In the event of clandestine or illegal immigration, both at national as well as Community level, measures shall be taken to guarantee that illegal immigrants enjoy and exercise their fundamental human rights.

2. The fundamental human rights of expelled immigrants or of the immigrant subject to such a measure by virtue of the laws and regulations of the host Member State, as well as the benefits accruing from his employment, shall be respected. Any expulsion orders shall be enforced in a humane manner without injury to the person, rights or properties of the immigrant.

3. Any person under an expulsion order shall be given a reasonable period of time to return to his country of origin.

4. Any expulsion order which may lead to the violation of fundamental human rights is prohibited.

5. By virtue of the fundamental human rights enjoyed by clandestine immigrants, host Member States shall ensure that repatriation takes place under legal and properly controlled procedures.

6. Where it is absolutely necessary, expulsion shall be contemplated solely on strictly legal grounds; in any case, it shall be effected with due respect for the human dignity of the expelled immigrant.

7. Any immigrant citizen of the Community travelling to a Member State other than his State of origin or desiring to reside or establish in such a Member State shall fulfill the conditions stipulated under the different Protocols on the free movement of persons, right of residence and establishment.

**CHAPTER IV
PROVISIONS COVERING THE TREATMENT OF
ILLEGAL IMMIGRANTS**

Article 5

1. Member States shall take all possible steps to ensure or facilitate the obtaining of the correct documents by illegal immigrants, if desired and possible.

2. The regularisation of the status of illegal immigrants shall be effected under the conditions stipulated in the different Protocols relating to the free movement of persons, the right of residence and establishment and on the basis of the following factors;

- the existence of an ample political consensus making regularisation of stay desirable or necessary;
- the acceptability of the immigrants by a large section of society;
- deadline of admissibility;
- a well-conceived information campaign directed at the entire population and designed to ensure their support and understanding;
- the absence of legal punitive measures against persons wishing to regularise their stay.

CHAPTER V

**SUB-REGIONAL COOPERATION FOR THE
PURPOSE OF PREVENTING OR REDUCING THE
FLOW OF ILLEGAL IMMIGRANTS**

Article 6

1. With a view to reducing both the attractions as well as the phenomenon of illegal immigrants, measures taken on a national, sub-regional or regional scale must be initiated through bilateral or multilateral cooperation.

2. Member States undertake to work together to reduce and eliminate the incidence of clandestine immigration as well as the smuggling of illegal workers

CHAPTER VI

**PROTECTION OF PROPERTIES LEGALLY
ACQUIRED BY IMMIGRANTS WHO ARE
CITIZENS OF THE COMMUNITY**

Article 7

1. The host Member State shall protect properties legally acquired on her territory by immigrants who are Community citizens, and shall respect their rights deriving therefrom.

2. Member States shall not apply any measures detrimental to the properties, rights and benefits legally acquired on their territory by citizens and nationals of other Member States which would not be applicable to their own nationals under the same conditions.

3. Any measure taken by a Member State which is detrimental to goods, movable properties or fixed assets legally acquired by Community citizens who are nationals of another Member State shall be liable to payment of a fair and equitable compensation.

4. Host Member States shall not enact any tax laws of a kind that may result in a less favourable treatment of immigrant Community citizens residing or established in their territories. This provision applies to both natural and legal persons.

5. Community citizens who are nationals of a Member State shall have on the territories of other Member States, under the same conditions as their nationals, freedom to prosecute and defend their rights under any jurisdiction.

CHAPTER VII

OBLIGATIONS OF MEMBER STATES IN RESPECT OF FURNISHING THE EXECUTIVE SECRETARIAT AND OTHER MEMBER STATES WITH INFORMATION IN THE EVENT OF BORDER CLOSURE BY ONE OF THEM

Article 8

1. Whenever a problem of internal security shall lead to the imposition of measures restricting the implementation of the provisions of the Protocol on free movement of persons, the right of residence and establishment, the Member State concerned shall inform the Executive Secretariat and other Member States within a reasonable period of time.

2. Whenever, for reasons of internal security, a Member State shall deem it necessary to close its borders, the Member State concerned shall inform the Executive Secretariat, and the other Member States, if necessary even after the act, regardless of the reasons justifying such measures.

CHAPTER VIII

MISCELLANEOUS PROVISIONS

Article 9

Any dispute which may arise between Member State regarding the interpretation or application of this Protocol shall be settled in conformity with the procedure for the settlement or disputes stipulated in Article 56 of the Treaty.

Article 10

1. Any Member State may submit proposals for amendment or revision of this Protocol.

2. Any such proposals shall be submitted to the Executive Secretary who shall communicate them to other Member States within (30) thirty days of the receipt of such proposals. The amendments or revisions shall be examined by the Authority at the expiration of the thirty (30) days notice period given to Member States.

CHAPTER IX

DEPOSIT AND ENTRY INTO FORCE

Article 11

1. This Protocol shall enter into force provisionally upon signature by the Heads of State and Government of Member States and definitively upon ratification by at least seven (7) signatory States in accordance with the constitutional procedures applicable for each signatory Member State.

2. This Protocol and all the instruments of ratification shall be deposited with the Executive Secretariat which shall transmit certified true copies to all Member States and notify them of the dates of deposits of the instruments of ratification and shall register this Protocol with the Organisation of African Unity, the United Nations Organisation and all other Organisations.

3. This Protocol shall be annexed to and shall be an integral part of the Treaty.

4. In faith whereof, we the Heads of State and Government of the Economic Community of West African States have signed this Protocol.

DONE IN LOME ON THIS 6TH DAY OF JULY 1985 IN SINGLE ORIGINAL IN THE ENGLISH AND FRENCH LANGUAGES, BOTH TEXTS BEING EQUALLY AUTHENTIC.

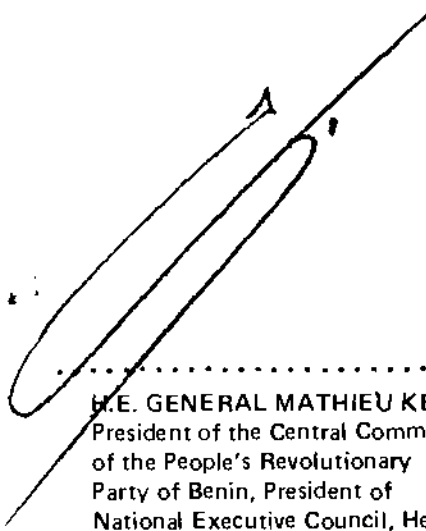

.....
H.E. GENERAL MATHIEU KEREKOU
 President of the Central Committee
 of the People's Revolutionary
 Party of Benin, President of
 National Executive Council, Head
 of State, President of the Republic

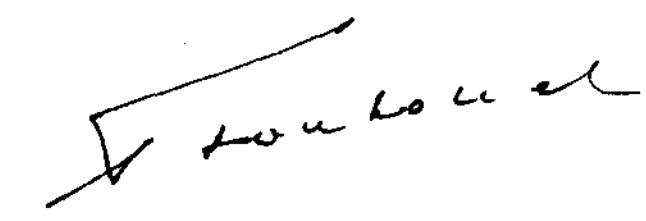

.....
H.E. MR. FELIX HOUPHOUET-BOIGNY
 President of the Republic of
IVORY COAST

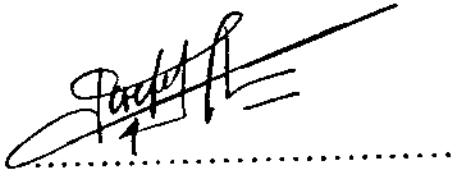

H.E. CAPTAIN THOMAS SANKARA
President of FASO



H.E. SIR DAUDA JAWARA
President of THE GAMBIA

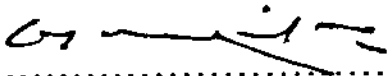

HONOURABLE MR. OSWALDO LOPEZ DA SILVA
Minister of Economic Affairs and
Finance, for and on behalf of the
President of the Republic of CAPE VERDE

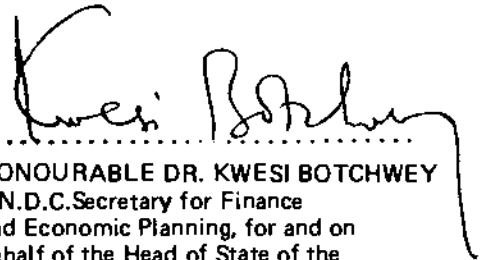

HONOURABLE DR. KWESI BOTCHWEY
P.N.D.C. Secretary for Finance
and Economic Planning, for and on
behalf of the Head of State of the
Republic of GHANA



H.E. COLONEL LANSANA CONTE
President of the Republic of GUINEA

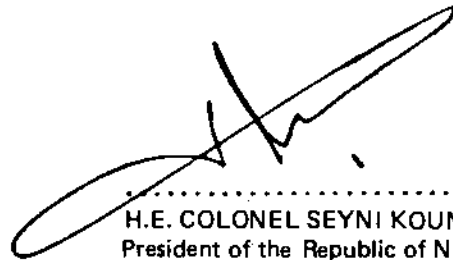

H.E. COLONEL SEYNI KOUNTCHE
President of the Republic of NIGER



HONOURABLE MR. MARIO CABRAL
Minister of Commerce and Tourism,
for and on behalf of the President
of GUINEA BISSAU

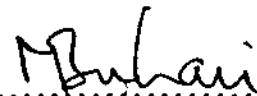

H.E. GENERAL MUHAMMADU BUHARI
Head of State of the Federal
Republic of NIGERIA

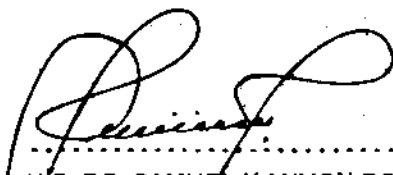

H.E. DR. SAMUEL KANYON DOE
Commander-in-Chief, Chairman of
the People's Redemption Council and
Head of State of LIBERIA

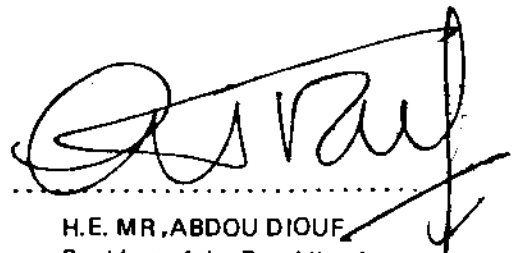

H.E. MR. ABDOU DIOUF
President of the Republic of
SENEGAL

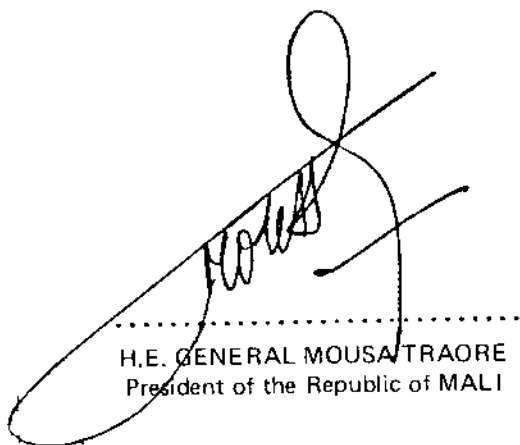

H.E. GENERAL MOUSSA TRAORE
President of the Republic of MALI



H.E. DR. SIAKA STEVENS
President of the Republic of
SIERRA LEONE



HONOURABLE LT. COL. ANNE MAMADOU BABALY
Minister of Finance and Commerce,
for and on behalf of the President of
the Islamic Republic of MAURITANIA

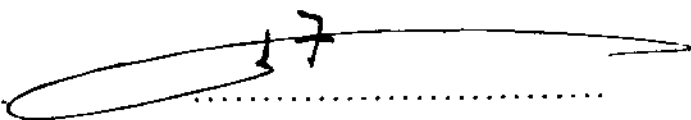

H.E. GENERAL GNASSINGBE EYADEMA
President of the Republic of
TOGO

A/DEC 1/7/85 DECISION OF THE AUTHORITY OF HEADS OF STATES AND GOVERNMENT OF THE ECONOMIC COMMUNITY OF WEST AFRICA STATES RELATING TO THE CONFIRMATION OF THE APPOINTMENT OF MR. MOMODU MUNU AS EXECUTIVE SECRETARY OF THE ECONOMIC COMMUNITY OF WEST AFRICAN STATES.

A/DEC. 2/7/85 DECISION OF THE AUTHORITY OF HEADS OF STATE AND GOVERNMENT OF THE ECONOMIC COMMUNITY OF WEST AFRICAN STATES RELATING TO THE ESTABLISHMENT OF ECOWAS TRAVEL CERTIFICATE FOR MEMBER STATES.

THE AUTHORITY OF HEADS OF STATE AND GOVERNMENT

THE AUTHORITY OF HEADS OF STATE AND GOVERNMENT,

- Mindful of Article 5 of the ECOWAS Treaty establishing the Authority of Heads of State and Government, its composition and powers;
- Mindful of Article 8 of the Treaty relating to the Appointment of Statutory Officers;
- Mindful of the Final Communique of the 7th Summit of Heads of State and Government of ECOWAS in Lome on the 22nd and 23rd of November 1984 offering the post of Executive Secretary of the Economic Community of West African States to the Republic of Sierra Leone;
- Mindful of the letter dated 26 January 1985 by the then Authority of Heads of State and Government appointing MR.MOMODU MUNU as the Executive Secretary of the Economic Community of West African States with effect from 1 January, 1985 for a probationary period of six months;
- Considering that MR.MOMODU MUNU has accomplished with satisfaction the six-month probation period referred to above;

- MINDFUL of Article 5 of the ECOWAS Treaty establishing the Authority of Heads of State and Government, and determining its composition and functions;
- CONSIDERING the Protocol on free movement of persons, the right of residence and establishment particularly the last paragraph of Article 1 relating to valid travel documents;
- CONVINCED of the need and advisability of adopting a harmonised travel document other than national passports for use within ECOWAS, in order to facilitate and simplify formalities governing movement of persons across the borders of Member States;
- CONVINCED of the premodial importance of the protocol on the free movement of persons, right of residence and establishment in the achievement of the fundamental objectives of ECOWAS Treaty.

DECIDES

Article 1

The appointment of MR.MOMODU MUNU as the Executive Secretary of the Economic Community of West African States is hereby confirmed with effect from 1 January, 1985.

Article 2

This Decision shall enter into force upon signature and shall be published in the Official Journal of the Community and in the National Gazette of each Member State.

DONE AT LOME ON 6TH JULY, 1985 IN ONE SINGLE ORIGINAL IN THE ENGLISH AND FRENCH LANGUAGES, BOTH TEXTS BEING EQUALLY AUTHENTIC.

FOR THE AUTHORITY

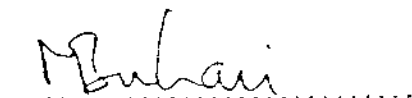

H.E.MAJOR GENERAL MUHAMMADU BUHARI
THE CHAIRMAN

DECIDES
FORM AND CONTENT OF DOCUMENT
Article 1

1. It is hereby established a travel document other than national passports, known as the "ECOWAS TRAVEL CERTIFICATE". It shall be in the format of a booklet measuring 12.5cm x 8.5 cm with a light blue hard cover bearing the ECOWAS emblem.
2. Apart from the two (2) pages which serve as part of the cover, the booklet shall consist of thirty-two (32) inside pages, each bearing visible ECOWAS emblems and, in light green fugitive ink, continuous inscription of ECOWAS - CEDEAO.
3. The inside pages shall be numbered from two (2) to thirty-two (32), assembled and designed in the format of an "exercise book". They shall bear at the top the title "ECOWAS - CEDEAO", Immigration/Emigration stamps (in English and French).
4. (a) The covers and inside pages shall bear at the top and in the centre a serial number made up of:
 - a code number of three (3) figures corresponding to the Statistical Code of the country of issue
 - a serial number
4. (b) The Issuing Authority shall give each ECOWAS Travel Certificate issued, a number written at the bottom of the first inside page, made up of:
 - the statistical code number of the Country of Issue

- the serial number
- year of issue

5. The first inside leaf shall bear :

- on the first side which shall be laminated, a photograph of the holder, stamped by the Authority issuing the ECOWAS Travel Certificate
- overleaf, the words "Minors accompanying the Holder".

In this space shall be inserted the surname, fore-names, date of birth and photograph of under-age members of the family accompanying the holder.

6. Page three (3) of the cover shall bear the following information (in English and French) :

- (a) on the upper half of the page :
- Date of expiry
 - Place and date of issue
 - Signature and stamp of the Issuing Authority

- (b) the lower half of the same page shall bear :
"The validity of this Travel Certificate is hereby extended until..."

DONE AT

DATE

- Signature and stamp of the Authority extending validity of the ECOWAS Travel Certificate.

Article 2

There shall be fixed on each ECOWAS Travel Certificate issued :

- a full-face identification photograph measuring 4 cm x 4cm
- a thumb-print and where applicable the signature of the holder;
- the signature and stamp of the issuing authority;
- the place and date of issue
- the expiry date.

CONDITION OF ISSUE AND EXTENSION

Article 3

1. Any national of a Member State may apply for issuance or extension of an ECOWAS Travel Certificate on condition that he has satisfied the requirements stipulated in the laws and regulations of his country of origin.

2. The Department responsible for issuance of travel document has national jurisdiction in this area and the applicant shall, therefore, address his application to the competent Authority in his country of origin. The application shall be directed to the nearest administrative Authority within the area of his domicile or principal place of residence.

Article 4

1. The ECOWAS Travel Certificate shall be issued or extended only on presentation of :

- a valid birth certificate, sworn affidavit in lieu of birth certificate or national identity card;
- four (4) 4 cm x 4 cm photographs
- a completed application form containing all necessary information for identification of the applicant. Where necessary, the applicant shall be required to give proof of his identity, his nationality and his occupation in accordance with the laws and regulations in force in his country of origin.

2. The ECOWAS Travel Certificate is issued on an individual basis, couples shall not be issued with one Single Certificate. Under-age children may be included on the Certificate of the accompanying adult. Any person above fifteen (15) years of age shall be required to obtain his own ECOWAS Travel Certificate.

3. Applications for the ECOWAS Travel Certificate shall attract a stamp duty of..... in accordance with the stamps and registry code of each Member State.

AUTHORITY EMPOWERED TO ISSUE ECOWAS TRAVEL CERTIFICATE

Article 5

ECOWAS Travel Certificate shall be printed and issued under the supervision and control of the competent national Authorities of each Member State. They shall be in English and French.

DURATION OF VALIDITY

Article 6

1. An ECOWAS Travel Certificate shall be valid for two (2) years from the date of issue. This period may be extended only once for two additional years.

2. A valid ECOWAS Travel Certificate may be used for several journeys.

SANCTIONS

Article 7

The following acts shall constitute an offence and shall be liable to legal proceedings which may be instituted according to the provisions of the Penal Code of each ECOWAS Member State :

- the issuance of an ECOWAS Travel Certificate under false pretences, i.e. on the basis of presentation of false DOCUMENTS, and the use of such an ECOWAS Travel Certificate ;
- the transfer, even temporarily, of an ECOWAS Travel Certificate or the use of a borrowed or stolen ECOWAS Travel Certificate;
- the forging, counterfeiting or alteration of an ECOWAS Travel Certificate thus counterfeited or altered.

FINAL PROVISIONS

Article 8

A specimen of the TRAVEL CERTIFICATE of ECOWAS MEMBER STATES is appended to this Decision.

Article 9

Member States shall take all necessary administrative and legislative measures for the speedy implementation of this decision.

Article 10

This Decision shall enter into force upon signature and shall be published in the Official Journal of the community and in the National Gazette of each Member State.

DONE IN LOME, THIS 6TH DAY OF JULY 1985
IN ONE SINGLE ORIGINAL IN THE ENGLISH AND
FRENCH LANGUAGES, BOTH TEXTS BEING
EQUALLY AUTHENTIC

FOR THE AUTHORITY

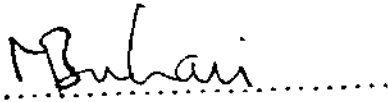

H.E. MAJOR GENERAL MUHAMMADU BUHARI
THE CHAIRMAN

C/DEC. 1/7/85 - DECISION OF THE COUNCIL OF MINISTERS RELATING TO THE CONFIRMATION OF THE APPOINTMENT OF THE MANAGING DIRECTOR OF THE ECOWAS FUND.

THE COUNCIL

MINDFUL of Article 6 of the ECOWAS Treaty establishing the Council of Ministers and defining its composition and powers;

MINDFUL of Article 28 paragraph 1 of the Protocol relating to the Fund for Cooperation, Compensation and Development of the Economic Community of West African States and to the appointment of the Managing Director of ECOWAS Fund;

MINDFUL of the Final Communiqué of the 7th Authority of Heads of State and Government of ECOWAS held in Lomé on 22 and 23 November 1984 offering the post of Managing Director of ECOWAS Fund to the Republic of Senegal;

MINDFUL of letter No. 82/MF/CAB dated 25 January 1985 by the Chairman of the Council of Ministers of ECOWAS appointing Mr. Mahenta Birima Fall as Managing Director of ECOWAS Fund with effect from 1 January 1985 for a probationary period of six months;

CONSIDERING that Mr. Mahenta Birima FALL has accomplished with satisfaction the six months probation period referred to above;

DECIDES:

Article 1

The appointment of Mr. Mahenta Birima FALL as Managing Director of ECOWAS Fund is hereby confirmed with effect from 1 January 1985.

Article 2

This Decision shall enter into force upon signature and shall be published in the Official Journal of the Community and in the National Gazette of each Member State.

DONE AT LOME 3 JULY 1985 IN ONE SINGLE ORIGINAL IN THE ENGLISH AND FRENCH LANGUAGES BOTH TEXTS BEING EQUALLY AUTHENTIC.

FOR THE COUNCIL



HON. DR. KOMLA ALIPIUI
THE CHAIRMAN

C/DEC 2/7/85 DECISION OF THE COUNCIL OF MINISTERS RELATING TO THE FINANCING OF THE CONSTRUCTION OF THE HEADQUARTERS OF THE ECOWAS FUND IN LOME, REPUBLIC OF TOGO

THE COUNCIL

MINDFUL of Article 6 of the ECOWAS Treaty establishing the Council of Ministers and defining its composition and functions;

CONSIDERING Decision A/DEC 17/5/82 of the Authority of Heads of State and Government relating to the construction of the Headquarters of the Institutions of the Community;

MINDFUL of Decision C/DEC 6/11/82 of the Council of Ministers relating to the procedure for the construction of the Headquarters of the Community Institutions;

IN ACCORDANCE with Decision No. F-BD/CA-13-84/3B recommending that the financing of the Fund Headquarters be made of 40% from the resources of the Fund and 60% from external loans;

CONSIDERING the meetings of Finance Experts and Committee of Experts of Ad Hoc Ministerial Committee held in Lomé from 16 to 18 May 1985 and 28 June 1985 respectively .

DECIDES;

Article 1

The Fund Management should pursue on-going negotiations with external financial sources for the best terms of financing to enable the Council make a decision during the November 1985 session.

Article 2

The mobilization of funds should be undertaken at the same time as the launching of the tenders.

Article 3

This Decision shall enter into force upon signature and shall be published in the Official Journal of the Community and in the National Gazette of each Member State.

DONE AT LOME 3 JULY 1985 IN ONE SINGLE ORIGINAL IN THE ENGLISH AND FRENCH LANGUAGES BOTH TEXTS BEING EQUALLY AUTHENTIC.

FOR THE COUNCIL



HON. DR. KOMLA ALIPIUI
THE CHAIRMAN

C/DEC 3/7/85 DECISION OF THE COUNCIL OF MINISTERS RELATING TO THE CHOICE OF A MODEL FOR THE CONSTRUCTION OF THE HEAD-QUARTERS OF THE EXECUTIVE SECRETARIAT IN ABUJA (FEDERAL REPUBLIC OF NIGERIA)

THE COUNCIL

MINDFUL of Article 6 of the Treaty establishing the Council of Ministers and defining its composition and functions ;

CONSIDERING the Decision of the Heads of State and Government allocating the Headquarters of the Executive Secretariat and the Fund to the Federal Republic of Nigeria and the Republic of Togo respectively;

IN ACCORDANCE with Decision A/DEC.17/5/82 of the Heads of State and Government establishing the Ad Hoc Ministerial Committee for the Construction of the Headquarters of the Community ;

CONSIDERING the Report of the Meeting of Experts of the Ad Hoc Ministerial Committee for the Construction of the Headquarters of the Community held from 27 to 30 June, 1985;

DECIDES

Article 1.

The four winning models in order of merit are as follows :

- 1st Model No 6 - AIM Consultants (Nig.) Ltd in association with YUSUF MOHAMED Association (Nigeria)
 2nd Model no 1 - A.T.A.I. R.K.FARA (Togo)
 3rd Model No15 - EGBOR and Associates (Nig.)
 4th Model No11 - Messrs NIGER Consultants (Nigeria)

Article 2.

The cost for each project-design shall not exceed a maximum of five (5) billion CFA francs, an amount fixed, and not subject to revision, for the construction of the Headquarters of the Executive Secretariat at Abuja (Federal Republic of Nigeria).

Article 3.

The winner of the competition shall operate within the limits set in Article 2 above while taking into consideration the desired technical and town planning criteria.

Article

In the event that the winner of the competition does not fulfill the conditions laid down above the second bidder shall be retained.

Article 5

This Decision shall enter into force upon signature and shall be published in the Official Journal of the Community and in the National Gazette of each Member State.

DONE AT LOME ON 3RD JULY 1985 IN

ONE SINGLE ORIGINAL IN THE ENGLISH AND FRENCH LANGUAGES, BOTH TEXTS BEING EQUALLY AUTHENTIC.

FOR THE COUNCIL



HON. DR. KOMLA ALIPUI
THE CHAIRMAN

C/DEC 4/7/85 DECISION OF THE COUNCIL OF MINISTERS RELATING TO THE FINANCING OF THE HEADQUARTERS OF THE EXECUTIVE SECRETARIAT

THE COUNCIL

MINDFUL of Article 6 of the ECOWAS Treaty establishing the Council of Ministers and defining its composition and functions ;

CONSIDERING the decision of the Heads of State and Government relating to the allocation of the Headquarters of the Executive Secretariat and the Fund to the Federal Republic of Nigeria and the Republic of Togo respectively;

IN CONFORMITY with Decision A/DEC.17/5/82 of 29 May 1982 of the Heads of State and Government that the construction of the Headquarters of the Secretariat and the Fund in the Federal Republic of Nigeria and the Republic of Togo respectively should be financed by the Community;

FOLLOWING Decision NoC/DEC 6/11/82 of 17 November 1982 of the Council of Ministers stipulating that the same procedure should be followed for the construction of the Headquarters of both Community Institutions;

CONSIDERING the recommendation of the Ad Hoc Ministerial Committee at its meeting held in July 1984 in Lagos that the financing for the construction of the Fund Headquarters should be made up of 40% of Fund's resources and 60% loans from friendly financial sources :

DECIDES

Article 1

The Executive Secretariat shall comply strictly with Article 1 paragraph 8 of Decision C/DEC.6/11/82, stipulating that preliminary studies relating to the construction of Secretariat Headquarters shall be financed by a loan given by the Fund which will be refundable;

Article 2

The financing for the construction of the Headquarters of the Executive Secretariat shall be made up of 40% of Fund's resources and 60% to be borrowed on the best possible terms.

Article 3

The method of financing shall be in line with the following objectives :

- (i) implementation of the architectural contract;
- (ii) effective participation of firms established in the sub-region;
- (iii) maximum utilisation of local materials.

Article 4

The total amount to be spent on the construction of Headquarters shall not exceed five (5) billion CFA francs. This amount is not subject to revision.

Article 5

This Decision shall enter into force upon signature and shall be published in the Official Journal of the Community and in the National Gazette of each Member State.

DONE AT LOME ON 3RD JULY 1985 IN ONE SINGLE ORIGINAL IN THE ENGLISH AND FRENCH LANGUAGES, BOTH TEXTS BEING EQUALLY AUTHENTIC.

FOR THE COUNCIL



HON. DR. KOMLA ALIPIUI
THE CHAIRMAN

C/DEC 5/7/85 DECISION OF THE COUNCIL OF MINISTERS RELATING TO THE CHOICE OF PROJECT MANAGEMENT CONSULTANT FOR CONSTRUCTION OF THE HEADQUARTERS OF THE FUND IN LOME, REPUBLIC OF TOGO

THE COUNCIL

MINDFUL of Article 6 of the ECOWAS Treaty establishing the Council of Ministers and defining its composition and functions;

CONSIDERING Decision A/DEC.17/5/82 of the Authority of Heads of State and Government relating to the construction of the headquarters of the Institutions of the Community;

MINDFUL of Decision C/DEC 6/11/82 of the Council of Ministers relating to the procedure for the construction of the Headquarters of the Community Institutions;

CONSIDERING the report of the Meeting of the Committee of Experts held in Lome from 17 to 21 May 1985;

DECIDES

Article 1

The various companies in the tender for the Pro-

ject Management Consultant are hereby awarded the following points :

- Associated Consultants, Ghana : 77.97
- Milton & Richards, Liberia : 77.47
- Towry-Coker Associates, Nigeria : 64.65
- Krakue Mercer & Partners, Ghana : 61.65
- Cabinet AUBA Engineering of LOCOH-DONOU, Togo : 58.14
- BCEOM, Togo : 51.90
- Deji Oyenuga & Partners, Nigeria : 27.01

Article 2

In view of the fact that there was very little difference between the total points of the first and second firms the Fund shall negotiate with the two firms and choose the lesser bidder.

Article 3

During the negotiations the objectives shall be to ensure that the cost of the Project Management Consultant does not exceed 1% of the total cost of the construction project.

Article 4

The Fund shall contact the first two firms, asking them for proposals which shall include direct cost and additional cost to ensure that the Fund does not meet any other obligations.

Article 5

The winner shall submit all documents in the two official languages (English and French).

Article 6

The Sub-Committee of Experts composed of Benin, Nigeria and Togo shall help the Fund during contract negotiations and the preparation of contracts.

Article 7

This Decision shall enter into force upon signature and shall be published in the Official Journal of the Community and in the National Gazette of each Member State.

DONE IN LOME ON 3RD JULY, 1985 IN ONE SINGLE ORIGINAL IN THE ENGLISH AND FRENCH LANGUAGES, BOTH TEXTS BEING EQUALLY AUTHENTIC.

FOR THE COUNCIL



HON. DR. KOMLA ALIPIUI
THE CHAIRMAN

C/DEC 6/7/85 DECISION OF THE COUNCIL OF MINISTERS RELATING TO THE CHOICE OF CONTROL BUREAU FOR THE CONSTRUCTION OF THE HEADQUARTERS OF THE ECOWAS FUND IN LOME, REPUBLIC OF TOGO

THE COUNCIL

MINDFUL of Article 6 of the ECOWAS Treaty establishing the Council of Ministers and defining its composition and functions ;

CONSIDERING Decision A/DEC.17/5/82 of the Authority of Heads of State and Government relating to the construction of the Headquarters of the Institutions of the Community ;

MINDFUL OF Decision C/DEC.6/11/82 of the Council of Ministers relating to the procedure for the construction of the Headquarters of the Community Institutions ;

CONSIDERING the Report of the Meeting of the Ad Hoc Ministerial Committee on the construction of the Headquarters of the Community Institutions from 27 – 30 June, 1985 ;

DECIDES

Article 1

SOCOTEC Bureau, Togo, is hereby selected as Control Bureau.

Article 2

The functions of SOCOTEC shall, among other things, be a ten-year guarantee of technical control and supervision and fire safety.

Article 3

The cost of all assignments for SOCOTEC shall be negotiated at 0.70% of the total cost of works excluding the cost of road works and other networks.

Article 4

This Decision shall enter into force upon signature and shall be published in the Official Journal of the Community and in the National Gazette of each Member State.

DONE IN LOME ON 3RD JULY 1985 IN ONE SINGLE ORIGINAL IN THE ENGLISH AND FRENCH LAGUAGES, BOTH TEXTS BEING EQUALLY AUTHENTIC.

FOR THE COUNCIL



**HON. DR. KOMLA ALIPUI
THE CHAIRMAN**

C/DEC 7/5/85 DECISION OF THE COUNCIL OF MINISTERS ESTABLISHING A CONSULTATION AND CO-ORDINATION COMMITTEE BETWEEN ECOWAS MEMBER STATES FOR THE PROGRAMMING OF TRADE FAIRS AND SIMILAR COMMERCIAL EVENTS

THE COUNCIL

MINDFUL of Article 6 of the ECOWAS Treaty establishing the Council of Ministers and defining its composition and functions ;

CONSIDERING Decision C/DEC.5/5/82 of 26 May 1982 of the Council of Ministers relating to the programming of trade fairs,

CONSCIOUS of the importance of events such as fairs and exhibitions in the development of trade between Member States of the Community,

HAVING NOTED that the over-lapping of trade fairs and similar commercial events in the sub-region reduces the chances of success of such events ;

ON THE RECOMMENDATION of the Trade, Customs, Immigration, Monetary and Payments Commission adopted at its meeting held in Lome from 6 to 17 May 1985 ;

DECIDES

Article 1

It is hereby established a Consultation and Co-ordination Committee for the programming of trade fairs and similar events in ECOWAS Member States. The composition of this Committee shall be as follows :

1. Representatives of Member States with permanent structures for hosting trade fairs or with institutions for promoting external trade
2. One representative of the Federation of West African Chambers of Commerce.
3. One representative of the ECOWAS Executive Secretariat.

Article 2

1. The Consultation and Co-ordination Committee for the programming of trade fairs and similar events in ECOWAS Member States shall be guided by a Steering Committee which shall be made up of :

- one Chairman
- one first Vice-Chairman
- one second Vice-Chairman
- one Secretary.

2. The Secretariat of the Steering Committee shall be the ECOWAS Executive Secretariat.

3. Members of the Steering Committee shall be elected from among Members of the Consultation and Co-ordination Committee for renewable periods of two years.

Article 3

1. Activities of the Consultation and Co-ordination Committee shall be among others, the following tasks :

- the drafting of the rules of procedure of the Consultation and Co-ordination Committee for the programming of trade fairs and similar events in ECOWAS Member States.
- the formulation and regular updating of the time-table of trade fairs and similar events in the West African sub-region (trade fairs and special shows),
- the coordination of Member States' initiatives and assistance to be granted them to enable them participate in all commercial events taking place in the West African sub-region and elsewhere in the world,
- the search for financing and for all other means likely to facilitate the preparation and participation of Member States both at national level and at the level of the organising country,
- the consideration of Member States' information needs and of all other preoccupations concerning trade fairs and similar events in the West African sub-region and elsewhere. For this purpose, Member State shall on a regular basis indicate their requirements to the ECOWAS Executive Secretariat,
- establishment of a data bank on trade fairs and similar events in the West African sub-region and in other regions.

2. The Consultation and Co-ordination Committee shall meet at least once a year upon invitation of the Steering Committee.

Article 4

The cost of participating in the meetings of the Committees shall be borne by each Member State or member institution.

Article 5

Periodic reports on the activities of the Consultation and Co-ordination Committee for programming trade fairs and similar commercial events shall be made to the Trade, Customs Immigration, Monetary and Payments Commission with a view to making appropriate recommendations to the competent authorities of the Community.

Article 6

The Executive Secretariat is requested to take all possible measures to ensure the implementation of this Decision.

Article 7

This Decision shall enter into force upon signature and shall be published in the Official Journal of

the Community and in the Official Gazette of each Member State.

DONE IN LOME ON 3RD JULY, 1985 IN ONE SINGLE ORIGINAL IN THE ENGLISH AND FRENCH LANGUAGES BOTH TEXTS BEING EQUALLY AUTHENTIC.

FOR THE COUNCIL



THE CHAIRMAN

C/DEC 8/7/85 DECISION OF THE COUNCIL OF MINISTERS ON THE CREATION OF AN AD HOC MINISTERIAL COMMITTEE TO EXAMINE PROBLEMS RELATED TO THE ECONOMIC CRISIS IN MEMBER STATES OF THE COMMUNITY.

THE COUNCIL

MINDFUL of Article 6 of the ECOWAS Treaty establishing the Council of Ministers and defining its composition and functions;

CONSIDERING Resolution A/RES.1/11/84 on economic recovery, adopted by the Authority of Heads of State and Government on 23 November, 1984;

MINDFUL of item 6, paragraph 20 of the Final Report of the seventeenth session of the Council of Ministers held in Lome from 1 to 3 July, 1985 :

DECIDES**Article 1**

There is hereby established an Ad Hoc Ministerial Committee responsible for examining the problems related to the economic crisis in Member States of the Community.

Article 2

The Committee shall be made up of the following Member States :

- Chairman : TOGO
- Members : FASO
GHANA
NIGERIA
SENEGAL

Article 3

This Decision shall enter into force upon signature and shall be published in the Official Journal of the Community and in the Official Gazette of each Member State.

DONE IN LOME ON 3RD JULY 1985 IN ONE SINGLE ORIGINAL IN THE ENGLISH AND FRENCH LANGUAGES BOTH TEXTS BEING EQUALLY AUTHENTIC.

FOR THE COUNCIL

A handwritten signature in black ink, appearing to read 'K. Alipui', written in a cursive style.

HON. DR KOMLA ALIPUI
THE CHAIRMAN

C/RES 1/7/85 RESOLUTION OF THE COUNCIL OF MINISTERS RELATING TO THE CONFIRMATION OF THE APPOINTMENT OF MR. MOMODU MUNU AS EXECUTIVE SECRETARY OF THE ECONOMIC COMMUNITY OF WEST AFRICAN STATES

THE COUNCIL

- MINDFUL of Article 6 of the Treaty establishing the Council of Ministers, its composition and powers ;
- MINDFUL of Article 8 of the Treaty relating to the appointment of Statutory Officers :
- MINDFUL of the final communique of the 7th Summit of Heads of State and Government of ECOWAS in Lome on the 22nd and 23rd of November 1984
- HAVING been informed of the expiration on the 30th June, 1985 of the probationary period of six months fixed by the Heads of State and Government in 1984 ;
- CONSIDERING that Mr. Momodu Munu has accomplished with satisfaction the six months probation period referred to above;

HEREBY RESOLVES:

- TO recommend to the Authority of Heads of State and Government to confirm the appointment of Mr. Momodu Munu with effect from 1st January, 1985 as the Executive Secretary of the Economic Community of West African States.

DONE IN LOME THIS 3RD JULY, 1985 ,

FOR THE COUNCIL



HON/DR KOMLA ALIPUI
THE CHAIRMAN

C/RES 2/7/85 RESOLUTION OF THE COUNCIL OF MINISTERS RELATING TO THE ADOPTION OF A SUPPLEMENTARY PROTOCOL ON THE CODE OF CONDUCT FOR THE IMPLEMENTATION OF THE PROTOCOL ON THE FREE MOVEMENT OF PERSONS, THE RIGHT OF RESIDENCE AND ESTABLISHMENT.

THE COUNCIL,

MINDFUL of the Article 6 of the ECOWAS Treaty establishing the Council of Ministers and defining its composition and powers;

MINDFUL of the ECOWAS Treaty particularly Articles 2 paragraph (d) and 27 as amended by Decision A/DEC.8/5/82 of the Heads of State and Government dated 29th May, 1982;

MINDFUL of the Protocol on the Free Movement of Persons, the Right of Residence and Establishment ;

CONVINCED of the major importance of the Protocol on the Free Movement of Persons, the Right of Residence and Establishment in achieving the fundamental objectives contained in the ECOWAS Treaty

RECOGNISING that the effective implementation of the provisions of the texts concerning the free movement of persons, goods, services and capital by all the Member-States constitutes the foundation for the building of the Community and the harmonious development of all social, economic and cultural activities in the Sub-region for the well-being of the peoples of Member States of the Community ;

RECOGNISING the urgent need to establish a close and effective cooperation between the various administrations of Member States for mutual administrative assistance in the area of free movement of persons, goods, services and capital;

ON THE RECOMMENDATION of the Trade, Customs, Immigration, Money and Payments Commission adopted during its meeting held in Lome from the 24th to the 28th June, 1985 ;

PROPOSES to the Authority of Heads of State and Government to approve and adopt the attached Protocol on the Code of Conduct for the implementation of the Protocol relating to the free movement of persons, the right of residence and establishment.

DONE IN LOME THIS 3RD JULY 1985

FOR THE COUNCIL



HON/DR KOMLA ALIPUI
THE CHAIRMAN

C/RES 3/7/85 RESOLUTION OF THE COUNCIL OF MINISTERS ON THE ESTABLISHMENT OF A TRAVEL CERTIFICATE FOR ECOWAS MEMBER STATES.

THE COUNCIL,

MINDFUL of Article 6 of the Treaty establishing the Council of Ministers and defining its composition and functions;

MINDFUL of the Protocol on the Free Movement of Persons, the Right of Residence and of Establishment signed in Dakar on 29th May 1979, particularly in the last paragraph of Article 1 relating to the valid travel document;

CONVINCED of the dominant role of the Protocol on the Free Movement of Persons, the Right of Residence and Establishment in the attainment of the fundamental objectives of the ECOWAS Treaty ;

RECOGNISING that it is necessary and appropriate to adopt a harmonised travel document within

ECOWAS in order to facilitate the movement of persons and to simplify the formalities to be undergone at the borders of Member States:

the Convention relating to the temporary importation of passenger vehicles into Member States.

ON THE RECOMMENDATION of the Trade, Customs, Immigration, Money and Payments Commission adopted at its fifteenth meeting held in Lome from 6 to 17 May, 1985,

DONE IN LOME THIS 3RD JULY, 1985

HEREBY PROPOSES to the Authority of Heads of State and Government to approve and adopt the attached draft Decision establishing a Travel Certificate of ECOWAS Member States.

FOR THE COUNCIL

DONE IN LOME THIS DAY 3RD JULY 1985



HON. DR. KOMLA ALIPIUI
THE CHAIRMAN

FOR THE COUNCIL

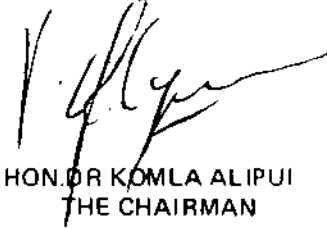

HON. DR. KOMLA ALIPIUI
THE CHAIRMAN

C/RES 4/7/85 RESOLUTION OF THE COUNCIL OF MINISTERS RELATING TO THE ADOPTION OF A CONVENTION ON THE TEMPORARY IMPORTATION OF PASSENGER VEHICLES INTO MEMBER STATES.

THE COUNCIL,

MINDFUL of Article 6 of the ECOWAS Treaty establishing the Council of Ministers and determining its composition and functions;

MINDFUL of Article 23 of the said Treaty;

CONSIDERING the provisions of Article 5 paragraphs 1 and 2 of the Protocol on the Free Movement of Persons, the right of residence and establishment as it affects the movement of private and commercial vehicles between Member States;

CONSIDERING the need to promote tourism within the Community with a view to achieving the harmonious development of this sector in Member States and to foster the free movement of persons in the sub-region;

CONSIDERING the need to regulate the temporary stay of passenger vehicles registered in one Member State entering another Member State;

CONSIDERING the need to adopt joint procedures on the temporary importation of passenger vehicles into Member States;

ON THE RECOMMENDATION of the Trade, Customs, Immigration, Money and Payments Commission adopted at its meeting held in Lome from 6-17 May, 1985.

PROPOSES TO THE AUTHORITY

TO approve and adopt the attached draft text of